

# Time-reversed human experience: Experimental evidence and implications

Dean Radin<sup>1</sup>  
Boundary Institute  
Los Altos, California

This paper reviews four classes of experimental evidence for time-reversed effects in human experience, examples of phenomena discussed in conventional scientific disciplines that bear a resemblance to time-reversed effects, and a new experiment that distinguishes between information flowing forwards vs. backwards in time. One implication of the cumulative evidence is that time-reversed effects permeate all aspects of human behavior. Another is that experiments in all scientific disciplines may be vulnerable to time-reversed influences, including studies based on gold-standard techniques like double-blind, randomized protocols. A third implication is that teleology, once taboo in science, deserves to be seriously reconsidered as another form of causation.

## Introduction

People like us, who believe in physics, know that the distinction between past, present, and future is only a stubbornly persistent illusion. – **Albert Einstein**

In negotiating the mundane activities of daily life, common sense is reasonably effective. But when faced with understanding the fabric of reality, common sense regularly fails. For example, we've learned that matter, energy, space and time are not the separate entities suggested by common sense, but rather they are deeply intertwined relationships. We've learned that light has no definite existence when no one is looking, at least not as we understand existence in common sense terms.

But perhaps one of the most self-evident concepts surprisingly questioned by modern science is causality. Cause and effect, the underlying scheme we use to understand "how things work," has generated more disquiet among scientists and philosophers than is commonly known. As Bertrand Russell put it in 1913,

All philosophers imagine that causation is one of the fundamental axioms of science, yet oddly enough, in advanced sciences, the world 'cause' never occurs .... The law of causality, I believe, is a relic of bygone age, surviving, like the monarchy, only because it is erroneously supposed to do no harm. (cited in Pearl, 2000, p. 337).

And as mathematician John von Neumann explained in 1955,

---

<sup>1</sup> I am deeply indebted to Edwin May, Richard Shoup, Russell Targ and Thomas Etter for many stimulating discussions about the nature of psi and causality.

We may say that there is at present no occasion and no reason to speak of causality in nature – because no [macroscopic] experiment indicates its presence ... and [because] quantum mechanics contradicts it. (cited in Rosen, 1999, p. 88).

In spite of questions about the fundamental nature of causality, cause→effect sequences certainly *seem* to be adequate for understanding experiences at the human scale. For example, we might expect that hitting a nail with a hammer provides proof-positive of a force-like, unambiguous causal event at the macro scale. You hit the nail with the hammer and it moves – end of argument. But what if the nail was stuck in a steel bar that looked like wood? Or if the nail was close to its melting temperature, or if the hammer was made out of foam rubber, or ....

We see that any example proposed as an irrefutable case of “absolute” causality can be easily qualified. And as soon as we start adding conditionals we are forced to redefine causation as a special form of asymmetric correlation, one with a higher probability link in one direction than the other. In this sense, ordinary notions of causality may be viewed a caricature of what is actually a set of highly complex, entangled relationships.

Still, while absolute causality may be an over-simplification, most social, behavioral and neuroscientists regard such arguments as philosophical quibbles, and they regularly use common sense causality to explain virtually all facets of human experience (Pearl, 2000). I agree that common sense causality is a useful heuristic tool, but I do not believe it provides an adequate explanation for *all* experiences. Why? Because substantial evidence indicates the presence of genuinely *acausal* experiences. “Acausal” in this context means “not causal in the unconditional, unidirectional, common sense notion of cause→effect, but in the sense of conditional, *time-reversed*, cause←effect relationships.”<sup>2</sup>

One expects a chorus of *a priori* objections to any suggestion of time-reversed causality. Some philosophers, like Anthony Flew, especially dislike the possibility of time-reversal effects because it forces us to seriously grapple with precognition and retroaction. As Flew wrote, if

both are to be defined in terms of “backwards causation,” this admission becomes the admission of a conceptual incoherence.... In these cases, although anomalous and statistically significant conditions may indeed have been found, these correlations most categorically cannot point to *causal* connections. (cited in Broderick, 1992, p. 134)

Flew may be correct when it comes to caricatures of absolute, unidirectional causality. But as we’ve seen, absolute causality dissolves like the Cheshire Cat when examined closely. And in spite of what common sense insists, many physicists and philosophers are far less certain than Flew when it comes to the meaning of “causal” (Price, 1996). In fact, hundreds of publications in mainstream journals can be found which consider the implications and properties of time-reversed and time-symmetric phenomena. These include

---

<sup>2</sup> This is different than the typical use of “acausal” in quantum physics. There it means “with no cause.”

effects described by the formalisms of classical mechanics, general relativity, electrodynamics, and quantum mechanics (e.g., Elsasser, 1969; Etter, in press; Tipler, 1974; Rietdijk, 1987; Travis, 1992; Schulman, 1999). Of course, the solutions to these theories are assumed to manifest only in exotic domains, e.g., under extremes of temperature, gravity, energy, mass or speed, or at very short time-periods. As a result, retrocausality is viewed as being possible in principle, but irrelevant for all practical purposes, or when it comes to understanding human experience.

While some exotic physical realms are clearly outside the scope of human experience, others are not. Under the right conditions, for example, we can perceive single quantum events, and neuronal synapses rely on electron "tunneling," a quantum effect that allows electrons to jump across forbidden energy zones (Hameroff, 1998; Wolf, 1999). We are not ordinarily aware of quantum or relativistic effects, but we are nevertheless composed of the same fabric of the universe as rocks, stars and blackholes. Thus, it is conceivable that exotic time-loops, reversals, symmetries and acausal correlations may lurk deep within us. If this were so, how might such experiences manifest? Consciously, they may emerge as precognitions of future events. And unconsciously, perhaps they would be experienced as intuitive hunches, gut feelings, and synchronicities.

From an anecdotal perspective, there is little doubt that such experiences exist. Time-reversed phenomena have been reported throughout history and across all cultures (Rhine, 1969; Radin, 1997b). Many such reports can be explained by prosaic psychological reasons, like coincidence, misperception, distortions and wish-fulfillment. But for over a century researchers have investigated these phenomena under carefully controlled laboratory conditions to see whether they are what they appear to be: genuine foreknowledge of non-inferable future events.

In this paper, I will argue that the cumulative evidence strongly suggests that time-reversals occur at the human scale, both consciously and unconsciously, and that these phenomena are more pervasive in human experience than previously thought. Let's begin by reviewing several classes of evidence for retrocausal effects.

## **Evidence**

There are two general sources of evidence for time-reversed phenomena in human experience: anecdotes and controlled experiments. While anecdotes provide face validity for the existence of these unusual experiences, they do not provide the trustworthy data required for scientific consideration. Thus, we will focus on the empirical evidence, in particular four classes of experiments. These include forced-choice tasks, precognitive remote perception, experiments involving psychophysiological measures, and tests involving present-time influence of data that was collected in the past.

## ***Forced-choice tests***

Honorton and Ferrari (1989) published a meta-analysis of all “forced-choice” precognition experiments conducted between 1935 and 1987.<sup>3</sup> In a forced-choice test, a person is asked to guess which one of say, six targets, will be selected later. The targets might be an array of colored lamps, ESP card symbols, or a die face. After making the guess, one target is randomly selected, and if the person’s guess matches the selected symbol, this is counted as a “hit.”

Honorton and Ferrari surveyed the English-language scientific literature to retrieve all experiments reporting forced-choice precognition tests. They found 309 experiments, reported in 113 articles published from 1935 to 1987, and contributed by 62 different investigators. The database consisted of nearly 2 million individual trials by over 50,000 subjects. The methods used in these studies ranged from the use of ESP cards to fully automated, computer-generated symbols. The future targets were selected with quasi-random methods, like the average daily low temperatures recorded in a large group of world cities, or via dice-tossing or card shuffling, or through the use of tables of pre-printed random numbers, or numbers generated by electronic random number generators (RNG). The time intervals between the guesses and the future targets ranged from milliseconds to a year.

The overall statistical result of the 309 studies was odds against chance of  $10^{25}$  to one (that is, ten trillion trillion to one). While this odds figure is impressively large, by itself it doesn’t prove anything. All it means is that we can confidently eliminate chance as a viable explanation. A second factor we must consider is whether the experiments were conducted properly, and Honorton and Ferrari’s analysis showed that variations in experimental quality could not explain the overall results. A third factor to consider is whether the meta-analytic result is due to a selective reporting bias – the so-called “filedrawer problem” – in which authors tend to publish experiments that are successful, but leave unsuccessful studies behind languishing in a filedrawer.

The filedrawer problem can be assessed by calculating the number of unpublished, unsuccessful studies required to nullify the observed statistical result. For forced-choice experiments, the number turns out to be 14,268. This would have required each of the 62 investigators who had conducted at least one precognition study to *also* have conducted an additional 230 unsuccessful experiments, and not to have reported a single one. Honorton and Ferrari concluded that the filedrawer problem was a most unlikely explanation given the time and effort required to conduct these studies.

Further analysis showed that 23 of the 62 investigators (37%) had reported successful studies, so the overall results were not due to one or two wildly successful (and therefore possibly suspect) investigators. The bottom line is

---

<sup>3</sup> A meta-analysis is a statistical method of assessing the results of numerous experiments exploring the same hypothesis.

that this body of experiments, conducted over half a century, provides strong evidence for precognition.<sup>4</sup>

Note that a precognition test differs from a psychokinesis<sup>5</sup> (PK) test in only one essential way: Say that you toss a pair of dice, and while the dice are still in the air you *wish* or intend to get a 7 when the dice land. This is a PK test. Now say that you toss the same pair of dice, and while the dice are still in the air you *guess* that you will get a 7 when the dice land. This is a precognition test. In the first case you *willed* a certain result; in the second case you *perceived* a future result. In both cases, the observable outcomes are identical.

It may seem that we could experimentally distinguish between PK and precognition by say, always wishing for 7s on successive dice throws. However, imagine that you could perceive the future outcome of dice throws. You'd know that if you threw the dice *now*, and with *this* particular twist, then you'd get the number that you wanted. You don't need to force anything unusual to happen, you just take advantage of your knowledge of future, spontaneous fluctuations in randomness. Thus, through precognition you could mimic the results of PK. There is no easy way to get around this experimental confound.

### ***Precognitive remote perception***

Overall, forced-choice experiments have provided persuasive evidence for precognition, but the effect sizes in those studies tend to be quite small. In an attempt to produce larger effects, researchers developed "free-response" experiments. These allowed participants to freely describe their impressions of a future target, rather than be forced to select one target out of a few possibilities. One such experiment was the precognitive remote perception experiment, conducted at the Princeton University Engineering Anomalies Research (PEAR) Laboratory (Jahn & Dunne, 1987).

The study went as follows: At time *t*, a "percipient" (P) made a written description and a sketch of a geographical location where P thought an "agent" (A) would be at time *t+x*. P also filled out a predefined check sheet asking for a quantitative answer to questions like "the degree to which water is present" at the site. Later, person A spent 10 to 15 minutes at a randomly assigned (or in some cases, self-selected) location. Then he recorded his impressions in writing, in the form of sketches, and using the same type of quantitative checklist that P filled out. A statistical evaluation was used to compare how well P's impressions, as captured on her checklist, matched A's description, as captured on his checklist. As part of the formal assessment, P's impressions were cross-matched against all other possible sites in the experimental database.

---

<sup>4</sup> For more details about this meta-analysis, refer to Honorton and Ferrari's (1987) original article, or to a summary in Radin (1997b).

<sup>5</sup> "Mind over matter," usually interpreted as a force-like interaction.

In 334 such trials contributed by some 40 people, the PEAR Lab reported odds against chance for the observed results at approximately 10 billion to 1. The time-displacement variable “x” in these studies ranged from -150 to +150 hours, and the observed precognitive (and retrocognitive) effect sizes were essentially the same regardless of the value of x. This type of experiment has been independently and successfully replicated many times (e.g., Targ & Katra, 1998).

## ***Psychophysiological studies***

Both forced-choice and free-response experiments ask participants to report their mental impressions about future targets. This is a time-honored method for gathering subjective data, but unfortunately, conscious experience is heavily distorted by psychological filters and defense mechanisms, and a large percentage of our perceptions never become conscious. To get around these problems, researchers have developed unconscious, physiologically-based techniques for detecting precognition.

### **Cortical measures**

For example, Levin & Kennedy (1975) used a reaction time task to see whether contingent negative variation (CNV), a slow brainwave indicator of anticipation, could be used to unconsciously detect a stimulus that would randomly appear in the future. Participants were asked to press a key when a green light appeared, but not when a red light appeared. An electronic RNG determined which light would appear. As predicted, significantly larger CNV's were observed just before the RNG selected a green light as compared to just before it selected a red light.

A few years later, Hartwell (1978) reported a similar study, also using CNV. Participants saw a picture of a person of the same sex or the opposite sex. If the picture was of the opposite sex, they pressed a button as quickly as possible, otherwise no response was made. Various forms of warning stimuli were used to alert the subject that a picture was about to be shown, from explicit warnings to prepare to respond, to no warning which served as the precognition condition. Thirteen of 19 planned statistical tests were in the predicted direction, but overall the results were not significant.

### **Autonomic nervous system measures**

In a more recent approach, I developed an experiment in “presentiment,” or pre-feeling. Under double-blind conditions, autonomic nervous system activity was monitored before, during and after a person viewed a randomly selected calm or emotional picture (Radin, 1997a). The calm pictures included pastoral scenes and neutral household objects, and the emotional pictures included erotic and violent scenes.

This experiment was designed to explore whether some intuitive hunches, especially “bad feelings” about upcoming decisions or actions, may be due to unconscious precognitive glimpses of future emotions. The basic design is

illustrated in Figure 1. A key feature of this experiment is that it provides a built-in control. That is, after display of emotional pictures the orienting reflex<sup>6</sup> is expected to appear. If it doesn't, it either means that the equipment isn't working properly, or that the person being tested is highly idiosyncratic in some way and should be eliminated from the experimental pool.

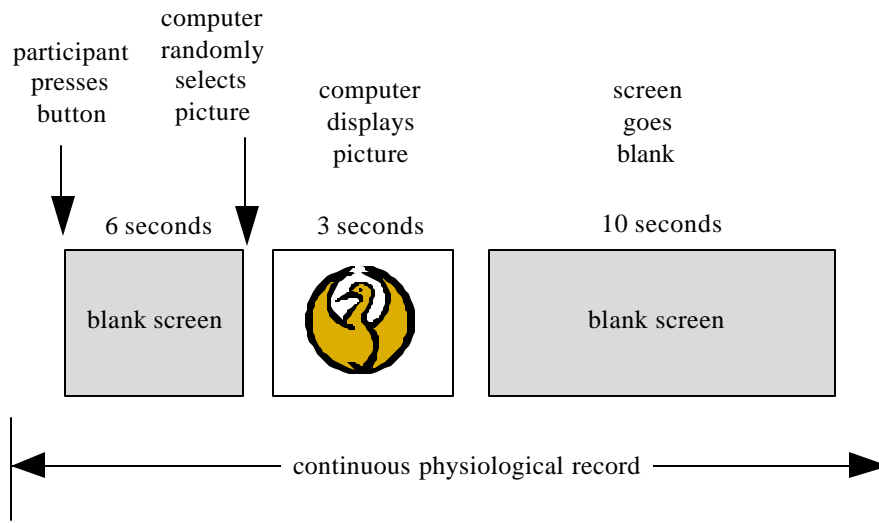

Figure 1. General design of presentiment experiment.

The graph in Figure 2 illustrates how presentiment effects appear in these experiments (Radin, 1997a). The two curves show average changes (and one standard error bars) in skin conductance before, during and after presentation of randomly selected emotional and calm pictures. Presentiment is observed as larger average arousal levels during the period *before display* of emotional pictures as compared to before calm pictures.

<sup>6</sup> Also known as the “fight or flight” response, the orienting reflex involves a constellation of specific physiological changes, including a drop in heart rate, a rise in skin conductance, dilation of the pupils, draining of blood from the periphery, and so on.

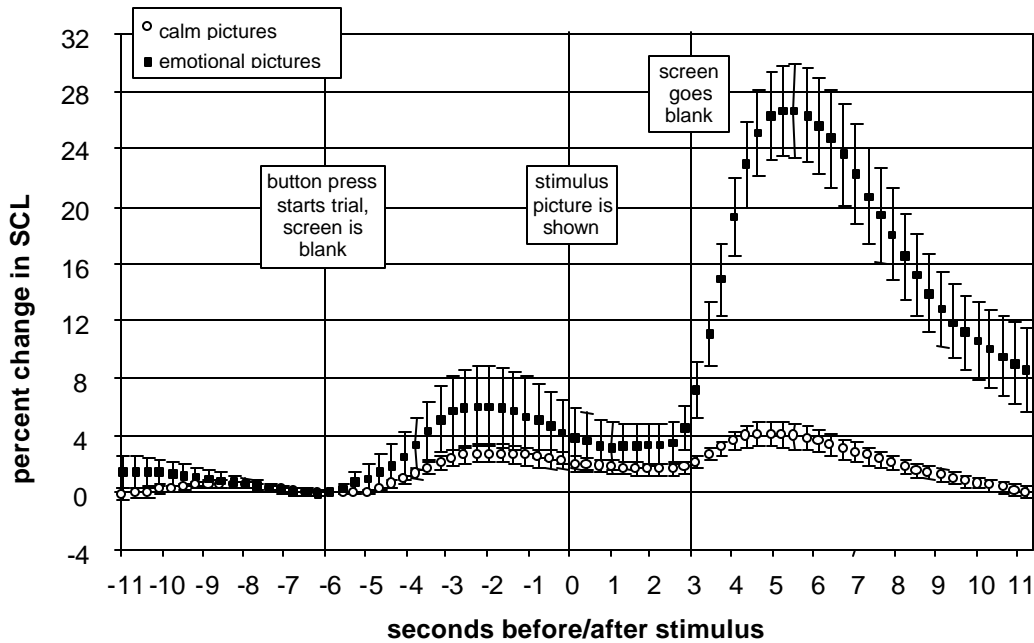

Figure 2. Results from a presentiment experiment. This person viewed 8 emotional and 21 calm pictures, randomly selected from a pool of 150 available pictures. The two curves show percent change in skin conductance level (SCL) averaged over all calm trials, and separately averaged over all emotional trials, with one standard error bars. The curves are clamped to zero with respect to the moment when each trial was initiated by the subject with a button press. The graph also shows SCL values five seconds before the button-press.

A similar analysis shown in Figure 3 shows skin conductance averages pooled across 25 individuals, each of whom saw 29 randomly selected pictures. The graph indicates that, on average, emotional vs. calm arousal levels began to differ within two seconds from the moment that these participants pressed the button to initiate each trial.



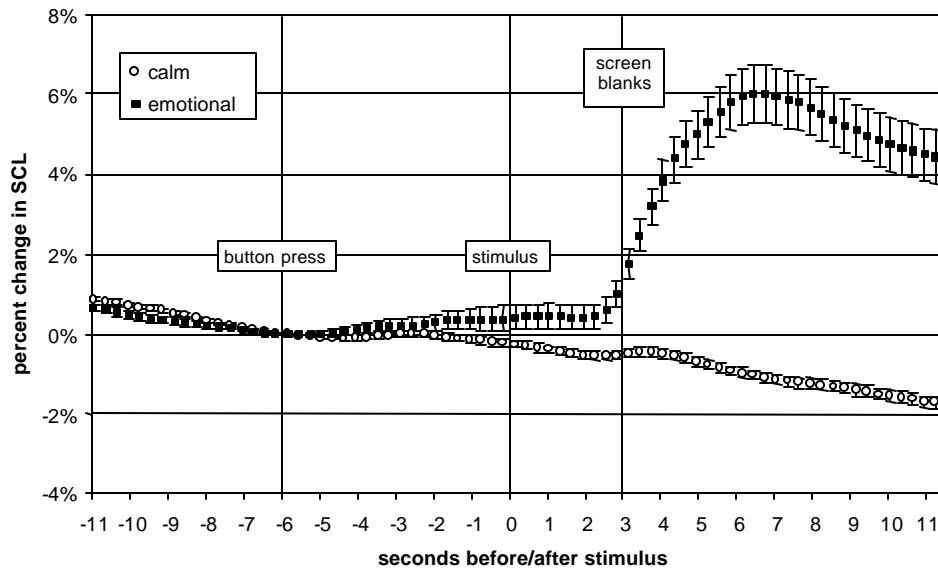

Figure 3. Percent change in skin conductance averaged across 25 participants, from 5 seconds before pressing the button to begin each trial to 11 seconds after the stimulus was observed.

In more general terms, presentiment postulates a correlation between *presponse* (i.e., physiological activity before the stimulus) and *response* (activity after the stimulus). This relationship can be tested by calculating the correlation between observed skin conductance levels vs. the emotionality level of each picture viewed in the experiment. The emotionality levels were determined beforehand by independent judges who rated each picture for its degree of subjective arousal.

Figure 4 shows the correlation resulting from the same 25 participants whose data are summarized in Figure 3. About two seconds *after* the stimulus there is a highly significant positive correlation between skin conductance arousal and subjective emotionality levels of the pictures. This means, as expected, that the strength of the orienting reflex is proportional to the emotionality of the pictures. In addition, as predicted by presentiment, a similarly significant positive correlation is observed *before* the stimuli were selected. This is important because it indicates that the participants were *presponding* proportionally to the emotionality of the future images, which is what we'd expect by a genuine time-reversed effect.

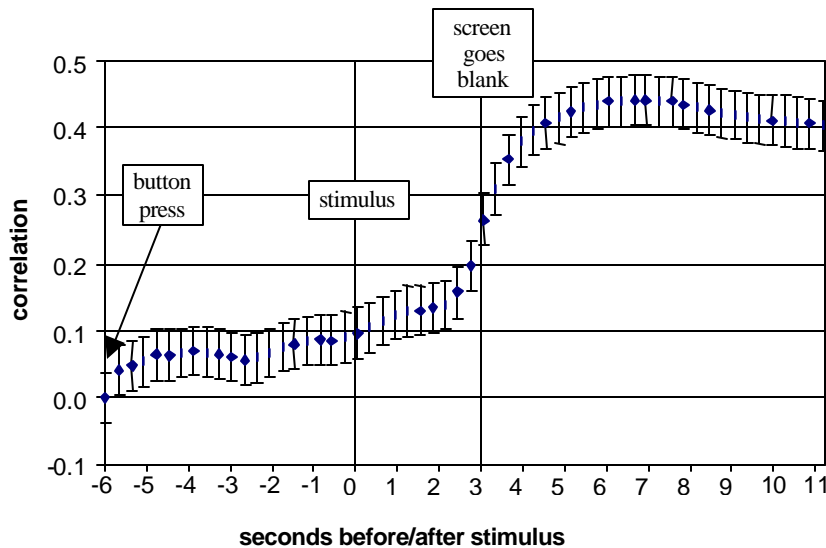

Figure 4. Correlations (and one standard error bars) between independently assessed target emotionality ratings vs. percent change in skin conductance level, across 25 participants.

This presentiment experiment is relatively new, so meta-analyses are not yet available to assess the repeatability of these effects. So far<sup>7</sup>, the experiment has been successfully replicated by Dick Bierman at the University of Amsterdam (Bierman and Radin, 1997, in press) and by students in the Psychology Department at the University of Edinburgh (Norfolk, 1999).

### ***Future influence of previously recorded data***

In all of the experiments just described, the basic method relies on consciously or unconsciously guessing future targets. There is another approach that more dramatically illustrates the close relationship between precognition and PK.

#### **Retro-psychokinesis**

The random number generator or “RNG” experiment is so-named because it involves an electronic circuit used to generate sequences of random bits. A computer is used to record the sequence of bits generated by the RNG and to provide feedback indicating the on-going random behavior. The feedback may be as simple as a video display of a line performing a random walk, or as sophisticated as a controller for a multimedia extravaganza. However simple or fancy the feedback may be, the participant is asked to mentally influence the RNG output in such a way that, in a pre-specified number of random bits, the RNG produces say, more 1’s than 0’s, depending on the instructions assigned by the experimenter.

In 1987, Roger Nelson and I conducted a meta-analysis of these RNG experiments (Radin & Nelson, 1989). The meta-analysis asked the question: Is

<sup>7</sup> As of June 2000.

the output of an electronic RNG related to an observer's mental intention in accordance with pre-specified instructions? From a wide range of sources, we found a total of 152 publications describing RNG studies conducted from 1959 to 1987. These reports described 832 experiments conducted by 68 different investigators, including 597 experimental studies and 235 control studies. The experimental results on average produced small percentage deviations from chance (generally less than 1%), but with sufficient consistency over so many trials that the overall odds against chance were well beyond a trillion to one. As with the forced-choice tests, the filedrawer problem could not reasonably explain these results, nor could variations in experimental quality. Studies conducted under control conditions, with no one attempting to influence the RNG, produced results well within expected values, with odds against chance of about two to one.

Bypassing a long list of increasingly persuasive arguments that these results are not due to any known flaws, we are eventually left with only one explanation: The RNGs in these studies were influenced by a real-time, "mind-over-matter" force. This interpretation of the results is not unreasonable, but a minor twist on the basic experimental design has cast doubt on this seemingly straightforward explanation.

Starting in 1975, investigators began to conduct RNG experiments in which (1) computers were used to automatically record long sequences of unobserved random bits, and (2) people were asked to influence those pre-recorded numbers according to instructions generated in the present (i.e., *after* the bits were generated). Participants in these experiments viewed the same sort of feedback as in the real-time RNG experiments described above, except, of course, in these "retro-PK" studies the random bits were retrieved off a computer's hard disk rather than generated in real-time. Thus, to be successful in these experiments, participants would have to influence *previously recorded* random bits.

Dick Bierman (1998) conducted a meta-analysis of these retro-PK studies. He found 26 studies contributed by 9 different investigators. The combined result was odds against chance of 18 million to 1. As far as anyone knows, there are no unpublished or unreported retro-PK studies, and therefore no filedrawer effect. This body of studies provides strong evidence that PK effects on RNGs are not limited to real-time "influences."

In addition to the 26 studies analyzed by Bierman, a retro-PK experiment organized by Matthew R. Watkins has been running over the Internet since 1996.<sup>8</sup> As of June 7, 2000, some 4,825 people have attempted to retroactively influence over 62 million pre-recorded random bits, and while the overall odds against chance are not quite significant (odds of 10.5 to 1), the results are consistent with the direction predicted by Bierman's meta-analysis. In addition, as part of a long-term series of RNG studies, the PEAR Laboratory found significant changes in RNG behavior regardless of the location of the

---

<sup>8</sup> This experiment is presently available on John Walker's web site, <http://www.fourmilab.ch/rpkp/>.

person trying to influence the RNG, and also regardless of *when* the person applied his or her intention. The odds against chance for the PEAR Lab's space and time-separated RNG tests were 75 to 1 (Jahn et al, 1997).

### **Retro-influence of behavior and activity**

Retro-PK studies using RNGs used random bits as the targets of retroactive influence. William Braud (2000) found 19 other retro-PK experiments where the targets of retroactive influence were natural fluctuations in the behavior of living systems. As in retro-PK RNG studies, these experiments asked people to influence previously recorded data using instructions that were randomly generated in the present. The pre-recorded data ranged from spontaneous fluctuations in human skin conductance and heart rate, to gerbils' use of an exercise-wheel, the paths of people walking randomly in a dark room while listening to pink noise, the times people spontaneously entered a supermarket, the times cars passed through tunnels during rush hour, and the growth rates of malaria parasites in rats. The combined results over all 19 studies, involving 233 individual sessions, produced odds against chance of 10 million to 1.

### ***Oblique time-reversed effects***

We would not expect genuine time-reversed effects to exist only in special experiments, or only for special people at special times. They might go unnoticed much of the time, but they must be ubiquitous if they exist at all. This being so, then besides precognition, how else might time-reversed effects masquerade? They may underlie some experiences of *déjà vu*, intuitive hunches, and synchronicities, but where else might we find them?

### **Mainstream literature**

I've already noted that hundreds of papers on time-reversal phenomena can be found without difficulty in the physics and philosophical literature. But surprisingly, it is also possible to find phenomena suggestive of time-reversed effects in the mainstream psychological and neuroscience literature. Sometimes the term "precognition" is mentioned apologetically; rarely are the experimental studies described here mentioned at all.

These effects include euphemisms such as "exceptional situational awareness," used to describe the performance of some jet fighter pilots who respond faster than they "should" be able to in combat dog-fights (Hartman & Secrist, 1991). Other terms include "anticipatory systems," used to describe how biological systems plan and carry out future behavior (Rosen, 1985), and various terms like "postdiction" (Eagleman & Sejnowski), "subjective antedating" (Wolf, 1998), "tape delay" (Dennett, 1992), and "referral backwards in time" (Libet, 1985), all referring to neurological mechanisms proposed to explain how sometimes we are conscious now of events that actually occurred in the past.

An example of the latter is the "color phi" effect described by Dennett (1992):

If two or more small [colored] spots separated by as much as 4 degrees of visual angle are briefly lit in rapid succession, a single spot will seem to move.... What happened to the color of “the” spot as “it” moved? The answer ... was striking: The spot seems to begin moving and then change color abruptly *in the middle of its illusory passage* towards the second location.... (emphasis in the original, p. 5).

The question is, How are we able to fill in the second color spot *before* the second flash occurs? In Dennett’s words:

Unless there is precognition in the brain, the illusory content cannot be created until *after* some identification of the second spot occurs in the brain. (Dennett, 1992, p. 5).

Dennett goes on to propose complex brain mechanisms based on metaphors like “tape delays” and “editing rooms” to account for this back-reference. However, as we’ve seen, another possibility is that the common sense notion of unidirectional time-flow is a convenient façade built upon a genuine time-reversed or time-symmetric reality.

### **Time-reversed effects in mainstream experiments**

If time-reversed effects are really pervasive, then they should sometimes be recognized as such, even by scientists who aren’t expecting to encounter them. An example of this is the case of Holger Klintman from the Department of Psychology at Lund University, Sweden. In the early 1980’s, Klintman (1983, 1984) was conducting a double-blind reaction time (RT) experiment based on a “Stroop task.”

The Stroop task goes as follows: Imagine a page of color-names printed in colored inks: green, blue, red and yellow. You are asked to read aloud the colors of the color-names as quickly as possible. It is well known that if the ink colors and names match, then the time it takes you to complete the task will be much shorter than if the colors and names mismatch. This differential effect, named after its discoverer, John Ridley Stroop (1935), is a remarkably robust effect that has spawned hundreds of experimental variations (MacLeod, 1991). The effect is attributed to cognitive -perceptual interference between the brain’s processing of colors versus color names.

Klintman was interested in improving the sensitivity of his measurements by calibrating each RT with a prior baseline RT. He asked people to first identify the color of a colored rectangle as quickly as possible, and then report (by speaking aloud) whether a color-name matched or mismatched the color of the rectangle. The initial color identification task was the baseline reaction time (RT1), and the second was a Stroop task (RT2).

To Klintman’s surprise, he found that RT1 was faster when the color -patch and color-name matched, and slower when they mismatched. Because an RNG randomly determined the match/mismatch condition *after* RT1 was already recorded, Klintman concluded that RT1 must have depended to some extent on RT2. He dubbed this backwards time effect “time reversed interference” (TRI). After conducting five TRI experiments, each using different designs to provide

conceptual replications, he concluded that TRI was not an artifact. The combined result for all five of his experiments was odds against chance of a million to 1.

A few years later, Gert Camfferman (1987) attempted a replication of Klinton's TRI experiment. His participants saw equal numbers of trials with a color patch followed by a name ("color-name" task), or a name followed by a color ("name-color"), and the order was counterbalanced within participants. He found a significant difference in average reaction times with the color-name task, but not with the name-color task. However, because he also discovered a positive correlation between RT1 and RT2, Camfferman concluded that Klinton's assumption that RT1 was independent of RT2 was wrong, and that the apparent TRI effects were really due to variations in general alertness than to a time-reversed effect. That is, if Alice had just quaffed a triple espresso, then she would be faster on both RT1 and RT2 than Betty, who had just enjoyed a bottle of wine.

While Camfferman's conclusion that RT1 and RT2 are related is undoubtedly correct to some extent, his assumption that Klinton's observations could be completely attributed to variations in alertness may have been premature. After all, Klinton hoped to exploit the known dependencies between RT1 and RT2 to form a more sensitive RT2, but in the process he discovered an unexpected differential effect that could not be explained simply as variations in alertness. To explore Klinton's findings and Camfferman's objections in more detail, Edwin May and I re-examined the TRI effect in three new experiments. Using new hardware, software and analytic methods, we successfully replicated the TRI effect with overall odds against chance of 125 to 1, and we also showed that the effect could not be solely attributed to variations in alertness (Radin & May, 2000).

### **Time-reversed effects in other mainstream experiments**

In 1997, I ran across an article describing an experiment that resembled my investigation of presentiment effects. The article described how neuroscientists had monitored brain activity and skin conductance during a gambling task (Bechara et al, 1997). They reported "compelling new evidence that intuition plays a crucial role in helping people make sensible decisions and clues to how 'gut feelings' work in the brain" (Stein, 1997). In examining their graphs in more detail, I was surprised to see that although they hadn't mentioned it, their results closely resembled the results I had observed in the presentiment experiments.

I noted this to my colleague, Dick Bierman, who became curious as to whether similar anomalies could be found in data from previously published, mainstream psychophysiological experiments. He was able to locate three suitable datasets that could be re-analyzed, all using skin conductance measures (Bierman, in press). The first was from an experiment on the speed with which fear arises in animal-phobic participants vs. controls (Globisch et al, 1999), the second was from Bechara's gambling studies (Bechara et al, 1994, 1996, 1997), and the third was from an experiment studying the effect of

emotional priming on the evaluation of Japanese characters (Murphy & Zajonc, 1993; LeDoux, 1996).

In all three datasets, Bierman found physiological anomalies closely resembling the presentiment effect. As predicted, skin conductance levels preceding randomized emotional stimuli were higher than before calm stimuli. The combined result across the three studies was significant, with odds against chance of 300 to 1, suggesting once again that retrocausal effects permeate human behavior, even experimental studies being conducted for other purposes.

### **Parapsychological literature**

Within the parapsychological literature, besides the evidence from explicit precognition and retrocausation experiments, another reversed-time anomaly has been observed: Post-experimental analysis of data significantly splits in accordance with the intentions or beliefs of the data analysts (e.g., Houtkooper & Haraldsson, 1985; Feather & Brier, 1968; Bierman & Houtkooper, 1981; Weiner & Zingrone, 1986; Kreiman, Ivinsky & Marquez, 1987). This so-called “checker effect” indicates that, as in the retro-PK experiments, sometimes already-recorded but not-yet-observed data is influenced by future decisions.

### ***Detecting the arrow of time***

We'll use a baseball metaphor to illustrate the purpose of the following experiment. Say you're interested in learning what happens when baseball pitchers throw curve balls. First, you put two posts in the ground directly in front of the pitcher's mound. The posts are spaced closely together, with just enough room for the ball to pass between them. The posts are positioned in such a way to ensure that when the ball leaves the pitcher's hand it is aimed straight at home plate. You force the pitcher to throw through this apparatus so when the ball actually reaches the plate you can measure how far it curved. Now you recruit some pitchers and ask them to throw their best curve balls. At home plate you use a high-speed camera to capture the ball's distance from the center of the home plate. You use the pictures from the camera to make precise measurements, and find that sometimes the ball has curved as much as 3 or 4 feet from the center line.

Now you assign an assistant to take photos of a few thousand curve ball pitches. A week later, you take the photos, measure the curve ball distances, do some calculations, and conclude that almost all of the curves can be attributed to spin that the pitcher had imparted to the ball. The exceptions are one or two pitches that, to your surprise, ended up nearly 9 feet from the center line! You calculate the amount of spin necessary to cause these deviations, and you discover that the force required to generate the required spin is far more than any human being could generate. Intrigued, you explore other explanations, such as gusts of wind, faulty measurements, miss-thrown balls, and everything else you can imagine. You end up rejecting all of these explanations.

In desperation you speculate that maybe outside the range of the camera your assistant arranged for a special machine to throw a curve ball *backwards*, starting somewhere from behind the plate. You don't tell anyone about this ridiculous idea, of course, but you nevertheless calculate whether the observed results are consistent with a backwards-going ball that was given an incredibly fast spin by a machine. You discover to your horror that the results are better described as a backwards-going ball than any plausible form of forwards-going ball.

By analogy with this baseball example, Thomas Etter and I designed an experiment designed to detect the direction of information flow in an RNG experiment.<sup>9</sup> On the surface, this experiment is similar to a classic RNG test. The difference is a new twist that provides a way to detect the direction that information flows.

The basic experimental system, a "Markov chain," is shown in Figure 8. A noise-based RNG is used to make random decisions to switch this binary system between the "1" and the "0" state. The first random decision, shown as R in Figure 8, generates a "1" or "0" with probability =  $\frac{1}{2}$ . Then two biased random decisions are made in sequence, each with transition probabilities  $p = .8$  or  $p = .2$ , as shown. These biased decisions are designed to keep the system in whatever state it was already in (with  $p = .8$ ), and switch it to the other state only occasionally (with  $p = .2$ ). One sweep through this three-step sequence requires three random decisions.

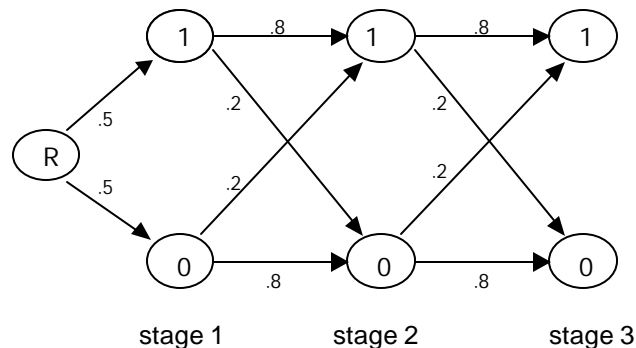

Figure 8. Random system defined as a Markov chain.

Imagine that we sweep through this chain  $N$  times. After each sweep, we'll calculate the proportional "hit rates" at stage 1, stage 2, and stage 3. The hit rate is defined as the number of times the system is in the 1 state vs. the total number of sweeps through the system. That is, hit rate is  $h = \sum(1's)/N$ . With some inspection it is easy to see that (with large  $N$ ) this particular Markov chain will produce hit rates  $h_1$ ,  $h_2$  and  $h_3$  of approximately 0.5.

<sup>9</sup> I am indebted to Thomas Etter for suggesting the basic idea of this experiment.



Now consider the sequence in Figure 9. The participant is simply asked to press a button with the intention of hearing a sound. After the button is pressed, three random decisions are made by an RNG, as shown in Figure 8. If the last transition results in a 1, then a sound is played, otherwise there is silence.

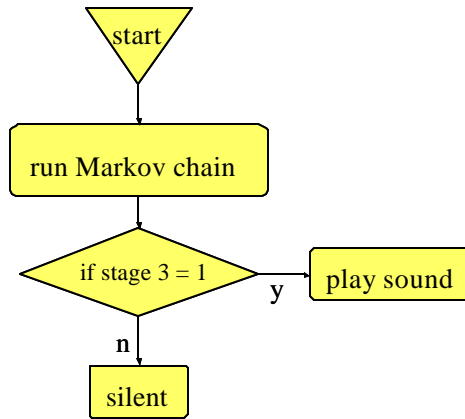

Figure 9. Markov chain experiment design.

If successful PK or precognition occurred in this test, then after many repeated trials the overall hit rate at stage 3 would be greater than 0.5. This would provide evidence for something unusual, but by itself it wouldn't tell us anything about what actually happened. In particular, we wouldn't know if the result was due to a process running forwards in time (PK) or one running backwards in time (precognition). The present experiment offers a possible answer. Let's see why.

Call each button press a *trial*, and one experimental *run* a group of 100 such trials. Now begin by performing a calibration test of the experimental system, consisting of 10,000 runs of 100 trials, using a RNG to make all random decisions without any human intervention.

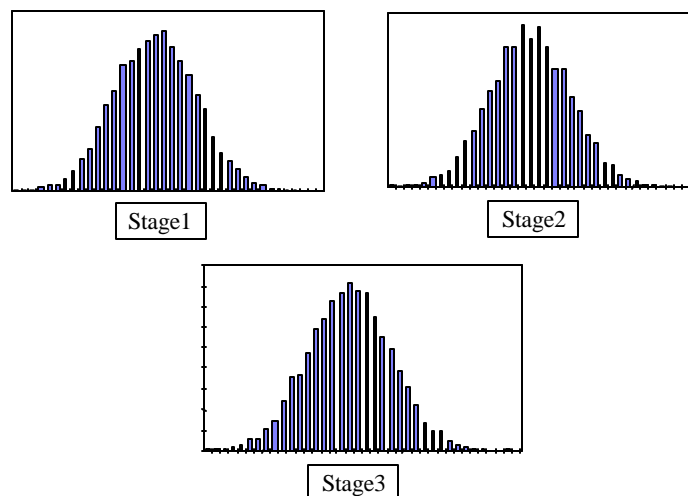

Figure 10. Calibration test results for precognition experiment.

The calibration results are shown in Figure 10 in the form of histograms of the number of 1's counted in Stages 1, 2 and 3 after each 100-trial run. We would expect a binomial distribution centered around 50 1's, and as we see all of the histograms are extremely close to theoretical expectation.

Now, what happens when we ask a human to press the button, intending to hear a sound each time? Figure 11 shows the cumulative hit rates per trial, produced in a total of six 100-trial runs by one participant. The graph shows that by trial 100 the cumulative average hit rate at Stage 3 ended up at  $h_3 = .55$ . Stage 2 showed somewhat less of a bias, and Stage 1 settled down close to chance expectation,  $h_1 = .50$ .

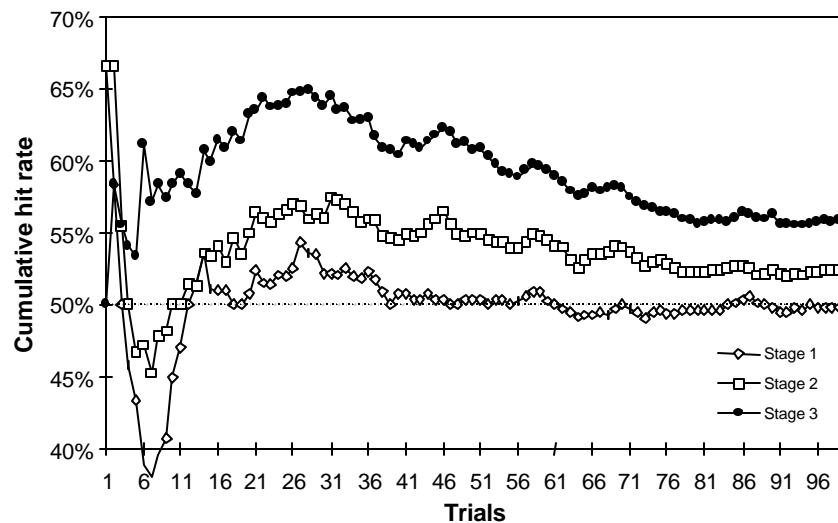

Figure 11. Cumulative average hit rates obtained in six runs of 100 trials each.

How likely are the results shown in Figure 11? Figure 12 shows these same hit rates in terms of odds against chance. We see that Stage 3 ended up with overall odds against chance of about 1,000 to 1. Given that the task in this experiment was to produce more 1's at Stage 3, this was a successful experiment. This is roughly analogous to that rare baseball that curves away from home plate by 9 feet, as compared to a pitcher's typical best effort of 3 feet.

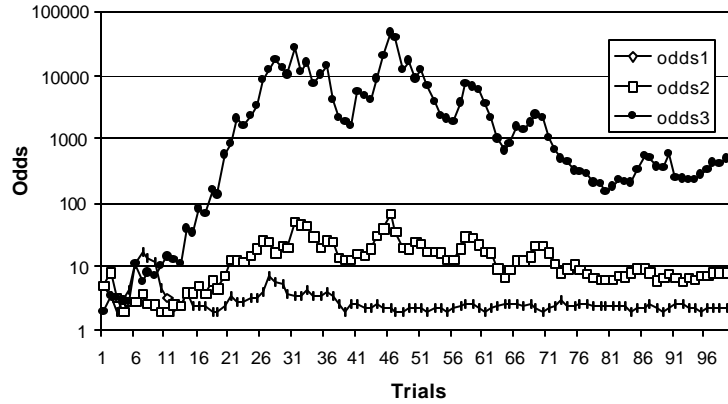

Figure 12. Results of precognition experiment in terms of odds against chance.

How do we explain this result? Let's say the results were caused by PK. This means the person mentally forced the RNG at Stage 1 to become biased in such a way as to produce the observed overabundance of 1's at Stage 3.

The question now becomes, what PK bias *would have been required* at Stage 1 to produce the observed hit rate at Stage 3? Calculation shows that to produce the final hit rate at Stage 3 of the observed  $h_3 = 56\%$ , we would have needed a final Stage 1 hit rate of  $h_1 = 70\%$ . This is shown in Figure 13. Unfortunately, the observed Stage 1 hit rate (the line labeled "Stage 1" in Figure 11) doesn't look anything like this, so another explanation is needed. This is analogous to calculating that the spin required to throw a curve ball that deviates by 9 feet is beyond human strength.

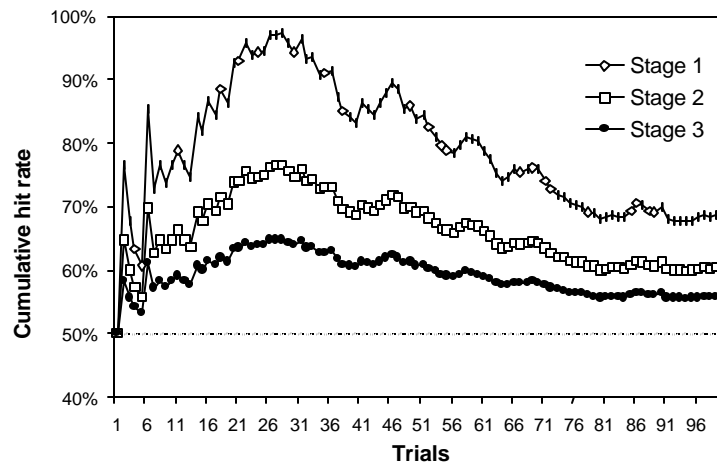

Figure 13. Bias required in Stage 1 to produce the experimentally observed results at Stage 3.

We had just assumed that the PK bias appeared only at Stage 1. But what if instead a small but constant PK bias was operating? By analogy, the above test assumed that a single, super-human spin was imparted to the ball before it was

thrown. Now we're asking what would happen if we imparted a small but continuous extra spin to the ball by using a special ball with a little gyroscope inside it. Calculations show (Figure 14) shows that a constant 3% PK bias applied to Stages 1 and 2 of the Markov chain can indeed result in the observed 56% outcome at Stage 3. But unfortunately, the shape of the curves in Figure 14 don't match the actual data shown in Figure 11. So a constant PK "spin" doesn't provide a viable explanation for these results.

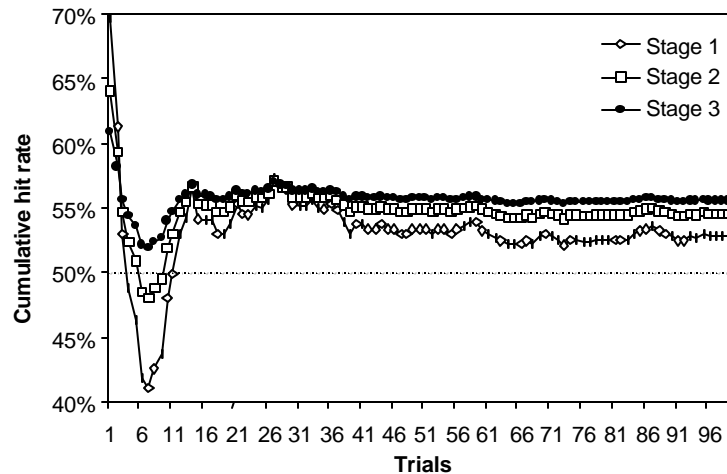

Figure 14. Results of a constant 3% forward-time bias. This produces the observed terminal hit rate for Stage 3 (56%), but the shape of the resulting curves do not resemble the observed results.

What if we *started* at Stage 3, and then ran *backwards* in time to calculate what the hit rates at Stage 2 and Stage 1 would look like, assuming no PK bias at all?<sup>10</sup> Figure 15 shows the answer. The line labeled Stage 3 shows the results originally observed at Stage 3. The line labeled Stage 2 shows what *would have happened* at Stage 2 if time ran backwards from Stage 3. And the line labeled Stage 1 is what we'd end up with at Stage 1 after running backwards from Stage 2. Now the curves for Stages 1 and 2 are much closer to the results observed in Figure 11. This suggests that a backwards-flow of information may be a better explanation than a forwards-flow.

<sup>10</sup> A Markov chain is completely time-symmetric, so we can just as easily run forwards as backwards through the chain.

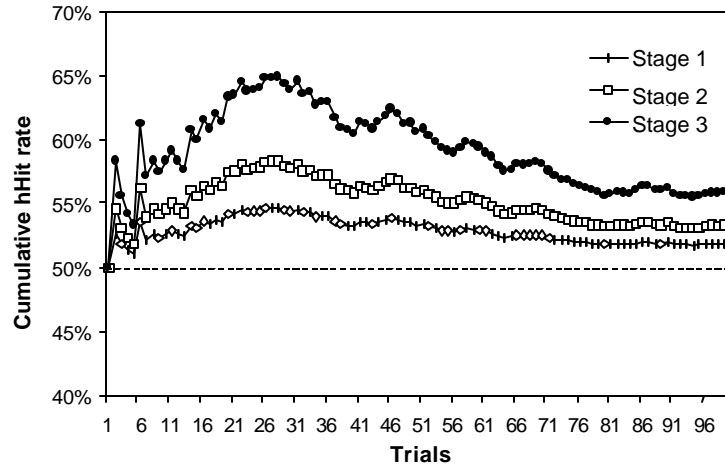

Figure 15. Results obtained by "running time backwards" from Stage 3 to Stage 1. Notice the similarity with the originally obtained results (Figure 11).

On closer examination, notice in Figure 15 that the Stage 1 cumulative hit rate ranged from about 52% to 54%, whereas in the original data the Stage 1 hit rate ranged from below 40% to about 54%. This discrepancy indicates that we need to adjust our backwards time explanation a bit. It turns out that if we run backwards from Stage 3, as in Figure 15, but with a constant 3% *backwards bias* applied to each stage, we end up with Figure 16. This now closely resembles the original data (in fact, it deviates by less than 1% after trial 50). This provides strong evidence that the results in this experiment were due to a backwards-flow of information with a small backwards retro-PK-type bias. In the baseball analogy, this strange result is like discovering that the only way to account for the especially large deviations in some curve balls is that they must have been thrown backwards, from the plate to the pitcher!

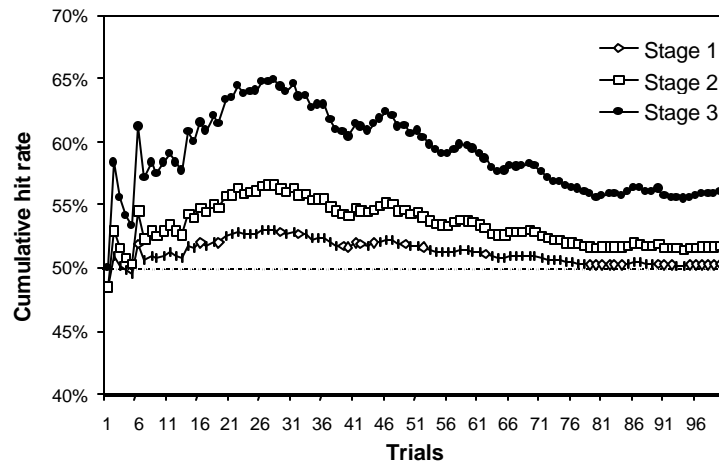

Figure 16. Results obtained with a process running backwards in time from Stage 3, with a constant 97% backwards bias.

## Discussion

The effects considered here involve information flowing backwards in time. This worries some philosophers because they imagine that time-reversals necessarily evoke logical paradoxes. That is, wouldn't information from the future change the present and thereby change the very future from whence the information originated? And wouldn't this create an inescapable temporal recursion?

The answer is yes, but only under two special conditions: First, if the future is absolute or fated to occur in only one way, and second, if precognition is perfectly accurate. However, if the future is inherently probabilistic, or if precognition is imperfect, or both, then the paradox dissolves. In any case, it is not suggested here that time-reversed effects *change* the past. As William Braud (2000) put it,

Once an event has occurred, it remains so; it does not "un-occur" or change from its initial form. It appears, instead, that the intentions, wishes, or PK "efforts" influence what happens (or happened) in the first place.

In other words, time-reversed effects appear to probabilistically influence past events that were disposed to being influenced, but the same influence cannot *change* what actually *did* occur, nor can it change events that are not susceptible to probabilistic influence.

One implication about time-reversal is that it raises questions about the meaning of "controlled" in controlled scientific experiments. It also questions how to properly interpret experimental data. Rigorously designed experiments are expected to control for factors like environmental contamination and experimenter expectancies. Techniques like electromagnetic and acoustic shielding, and double-blind, randomized protocols were developed to enact these controls. However, these gold-standard design features are inadequate in controlling the *transtemporal* influences we've discussed here.

Conventional experiments assume without question that once data has been collected, the final results are fixed. Apparently, this assumption is not always true. It is conceivable that any experiment that involves either random elements, or human decisions made before or during data collection, may be vulnerable to time-reversed influences. With few exceptions, this includes nearly all experiments in all scientific disciplines. In addition, while the magnitude of time-reversed influences is not well understood, it is plausible that some well-known experimental biases attributed to other causes, such as Rosenthal's "experimenter expectancy effect," may have time-reversed components (Barber, 1976; Rosenthal, 1976; 1978).

A second major implication of the phenomena discussed here is that a case can be made for a serious resurrection of Aristotle's "final cause." Sidestepping the difficult questions about whether we should more profitably think of causality in terms of force or correlation, most scientists today assume that of Aristotle's

four causes<sup>11</sup> the only one worthy of serious attention is “efficient cause.” The efficient cause in say, building a chair involves the act of a hammer hitting a nail into wood, material cause refers to the wood and nails involved in making a chair, formal cause refers to the design of the chair, and final cause refers to the underlying purpose of the chair.

While modern science has considered material and formal causes to be interesting but irrelevant in understanding the mechanisms of chair construction, final cause is dismissed entirely because teleology is thought (by some) to suspiciously resemble theology. But what if these guiding purposes are not gifts from the gods, but influences from our future? In conventional terms, this is essentially the thrust of research on “anticipatory systems” in biological and computing systems (Rosen, 1991). But here, of course, I mean more than goals created by our capability to inferentially forecast the future. I mean goals that actually come *from the future*, through time-reversed processes.

## Conclusion

As shocking as it would have been to 18<sup>th</sup> century scientists, time-reversed and time-symmetric effects were predicted and later confirmed by 20<sup>th</sup> century physicists. In the 21<sup>st</sup> century, I believe we will find increasingly strong reasons to believe that similar temporal anomalies exist not only in exotic realms, but also in the more intimate domain of human experience.

The full epistemological and ontological consequences of time-reversal phenomena have yet to be worked out, but one early implication is that the experimental sciences are faced with a puzzling dilemma: Time-reversed effects cannot be prevented by any known experimental controls. As we’ve seen, several hundred rigorously controlled experiments, including those using double-blind, randomized protocols, have demonstrated that all known expectation and sensory shielding methods cannot stop time-reversed influences. This means that the best-controlled experiments across all scientific disciplines are fundamentally and unavoidably flawed. We may take some comfort in assuming that the magnitude of these flaws are generally small, but in some disciplines, especially labile domains like the life sciences, these flaws may seriously affect the interpretation of results.

These implications, of course, are heresies of the first order. But I believe that if the scientific evidence continues to compound, then the accusation of heresy is an inescapable conclusion that we will eventually have to face. I also believe that the implications of all this are sufficiently remote from engrained ways of thinking that the first reaction to this work will be confidence that it is wrong. The second reaction will be horror that it may be right. The third will be reassurance that it is obvious.

---

<sup>11</sup> Efficient, material, formal and final.

## References

- Barber, T. X. (1976). *Pitfalls in human research: Ten pivotal points*. New York: Pergamon Press, Inc.
- Bechara, A. R. Damasio, H. Darnasio, S. W. Anderson, (1994). Insensitivity to future consequences following damage to human prefrontal cortex. *Cognition* 50, pp. 7-15.
- Bechara, A., Tranel, D., Damasio, H. and Damasio, A. R. (1996). Failure to respond autonomically to anticipated future outcomes following damage to prefrontal cortex. *Cerebral Cortex* 6, pp. 215-225.
- Bechara, A., Damasio, H., Tranel, D., Damasio, A. R. (1997). Deciding advantageously before knowing the advantageous strategy. *Science*, 275, 28 February 97, 1293-1295.
- Bierman, D. J., and Houtkooper, J. M. (1981). The potential observer effect or the mystery of irreproduceability, *European Journal of Parapsychology*, 3(4), 345-372
- Bierman, D. & Radin, D. I. (in press). Anomalous unconscious emotional responses: Evidence for a reversal of the arrow of time. To appear in *Tuscon III: Towards a science of consciousness*, MIT Press.
- Bierman, D. J. & Radin, D. I. (1997). Anomalous anticipatory response on randomized future conditions. *Perceptual and Motor Skills*, 84, 689-690.
- Bierman, D.J. (1998). Do psi phenomena suggest radical dualism? In: Stuart R. Hameroff , Alref W. Kaszniak, and Alwyn C. Scott (Eds), *Toward a science of Consciousness II*, The MIT Press, Cambridge MA, pp. 709-714.
- Braud, W. (2000). Wellness implications of retroactive intentional influence: Exploring an outrageous hypothesis. *Alternative Therapies*, January 2000, Vol. 6, No. 1, p. 37-48.
- Broderick, D. (1992). *The lotto effect*. Marrickville, New South Wales, Australia: Southwood Press.
- Camfferman, G. (1987). Time reversed interference: A replication study. *European Journal of Parapsychology*, 7, 13-31,
- Dennett, D. C. (1992). Temporal anomalies of consciousness. In Y. Christen and P. S. Churchland, eds., *Neurophilosophy and Alzheimer's disease*, Berlin: Springer-Verlag.
- Eagleman, D. M. & Sejnowski, T. (2000). Motion integration and postdiction in visual awareness. *Science*, 287, 2036-2038.
- Elsasser, W. M. (1969). Acausal phenomena in physics and biology, *American Scientist*, 57, 502-516.
- Etter, T. (in press). Process, system, causality, and quantum mechanics. *Physics Essays*.
- Feather, S. R., and Brier, R. (1968). The possible effect of the checker in precognition tests, *Journal of Parapsychology*, 32(3), 167-175
- Globisch, J., Hamm, A.O., Estevez, F., and Öhman, A. (1999). Fear appears fast: Temporal course of startle reflex potentiation in animal fear subjects. *Psychophysiology*, 36, pp. 66-75.
- Hammeroff, S. (1998). Quantum computation in brain microtubules? The Penrose-Hameroff "Orch OR" model of consciousness. *Philosophical Transactions Royal Society London (A)* 356:1869-1896.
- Hartman, B. O & Secrist, G. E. (November, 1991). Situational awareness is more than exceptional vision. *Aviation, Space, and Environmental Medicine*, 1084-1089.
- Hartwell, W. (1978) Contingent negative variation as an index of precognitive information. *European Journal of Parapsychology*, 2, 83-103.
- Honorton, C. & Ferrari, D. C. (1989). Future telling: A meta-analysis of forced-choice precognition experiments, 1935-1987, *Journal of Parapsychology*, 53, 281-308.
- Houtkooper, J. M., and Haraldsson, E. (1985). Experimenter effects in a plethysmographic ESP experiment, *European Journal of Parapsychology*, 5(4), 313-326
- Jahn, R. & Dunne, B. J. (1987). *Margins of reality*. New York: Harcourt Brace Jovanovich Publishers, p. 149-191.



- Jahn, R. G., Dunne, B. J., Nelson, R. D., Dobyns, Y. H. and Bradish, G. J. (1997). Correlations of random binary sequences with pre-stated operator intention: A review of a 12-year program. *Journal of Scientific Exploration*, 11 (3), 345-368.
- Klintman, H. (1983). Is there a paranormal (precognitive) influence in certain types of perceptual sequences? Part I. *European Journal of Parapsychology*, 5, 19-49.
- Klintman, H. (1984). Is there a paranormal (precognitive) influence in certain types of perceptual sequences? Part II. *European Journal of Parapsychology*, 5, 125-140.
- Kreiman, N., Ivniky, D., & Marquez, L. E. (1987). The checker effect, *Cuadernos de Parapsicologia* 20(1), 1-11
- LeDoux, J.E. (1996) *The emotional brain*. New York: Simon & Schuster.
- Levin, J. & Kennedy, J. (1975). The relationship of slow cortical potentials to psi information in man. *Journal of Parapsychology*, 39, 25-26.
- Libet, B. (1985). Unconscious cerebral initiative and the role of conscious will in voluntary action. *Behavioral and Brain Sciences*, 8, 529-566.
- MacLeod, C. M. (1991). Half a century of research on the Stroop effect: An integrative review. *Psychological Bulletin*, 109, 163-203.
- Murphy, S.T. & Zajonc, R. B., (1993). Affect cognition, and awareness: Affective priming with optimal and suboptimal stimulus exposures. *Journal of personality and social psychology*, 64 (5). pp. 723-739
- Norfolk, C. (1999). Can future emotions be perceived unconsciously? An investigation into the presentiment effect with reference to extraversion. Unpublished manuscript, Department of Psychology, University of Edinburgh.
- Pearl, J. (2000). *Causality: Models, reasoning, and inference*. New York: Cambridge University Press.
- Price, H. (1996). *Time's arrow and Archimedes' point*. New York: Oxford University Press.
- Radin, D. I. & May, E. C. (2000). Evidence suggestive of a retrocausal effect in the human nervous system. Boundary Institute Technical Report 2000-1.
- Radin, D. I. & Nelson, R. D. (1989). Evidence for consciousness-related anomalies in random physical systems. *Foundations of Physics*, 19, 1499-1514.
- Radin, D. I. (1997a). Unconscious perception of future emotions: An experiment in presentiment. *Journal of Scientific Exploration*, 11 (2), 163-180.
- Radin, D. I. (1997b). *The conscious universe: The scientific truth of psychic phenomena*. San Francisco: HarperCollins.
- Rhine, L. E. (1969). Case study review. *Journal of Parapsychology*, 33, 228-266.
- Rietdijk, C. W. (1987). Retroactive effects from measurements, *Foundations of Physics*, 17, 297-311.
- Rosen, R. (1985). *Anticipatory systems*. New York: Pergamon Press.
- Rosen, R. (1991). *Life itself*. New York: Columbia University Press.
- Rosen, R. (1999). *Essays on life itself*. New York: Columbia University Press.
- Rosenthal, R. (1976). *Experimenter effects in behavioral research*. Appleton-Century-Crofts, New York, 1966; enlarged ed., Irvington, 1976.
- Rosenthal, R. (1978). How often are our numbers wrong? *American Psychologist*, 33, 1005-1008.
- Schulman, L. S. (1999). Opposite thermodynamic arrows of time. *Physical Review Letters*, 83 (26), 5419-5422.
- Stein, R. (Friday, Feb.28, 1997, p. A14), With new findings, neuroscientists have a hunch intuition makes sense. *The Washington Post*.
- Stroop, J. R. (1935). Studies of interference in serial verbal reactions. *Journal of Experimental Psychology*, 18, 643-622.
- Targ, R. & Kutra, J. (1998). *Miracles of Mind*. Novato, CA: New World Library.
- Tipler, F. J.(1974). Rotating cylinders and the possibility of global causality violations, *Physical Review D*, 9, 8, 2203-220.
- Travis, J. (1992). Could a pair of cosmic strings open a route into the past? *Science*, 256, 179-180.

- Weiner, D. H., and Zingrone, N. L. (1986). The checker effect revisited, *Journal of Parapsychology*, 50(2), 85-121
- Wolf, F. A. (1998). The timing of conscious experience: A causality-violating, two-valued, transactional interpretation of subjective antedating and spatial-temporal projection. *Journal of Scientific Exploration*, 12 (4), 511-542.